



High+low frequency



- for large-area shielding of high-frequency electromagnetic waves, low-frequency alternating electric fields and dissipation of static charges
- best shielding effectiveness with the improved high frequency shielding paint HiFreq-Premium-Liquid.
- very good tensile adhesion in comparison to the Biologa Danell shielding paint HiFreq-Standard-Powder + -Liquid, can therefore also be used under tiles, for example
- very low-emission shielding paint for indoor and outdoor use
- metal-free, physically extremely stable, durable and non-oxidising, frost-resistant
- high water resistance, elastically soft
- highly electrically conductive wall coating based on synthetic resin. The paint is vapour diffusible and contains no solvents, plasticisers, low-volatile organic compounds, formaldehyde or ammonia.

HiFreq Premium Liquid adheres well to most non-greasy and load-bearing surfaces indoors and outdoors and can be easily painted or wallpapered over. Can be used under organic plasters after priming.

Painting over existing wallpaper is advisable if the shielding surface is to be removed without leaving any residue in the foreseeable future.

Possible top coats:

- plastic-bonded dispersion paints Dispersion
- silicate paints (KEIM - Ecosil, Biosil, Optil)
- clay paints: Volvox clay paint
- lime paints: Haga lime paint

Top coats only with prior test:

- mineral coatings (plasters) such as clay, lime or pure silicate

Order-No.: 201059

Short-Desc.: HiFreq-Premium-Liquid - 1 litre

Required accessories



Ground strap (AEB)



Grounding plate (EGP)

Shielding paint (HF+LF)

HiFreq-Premium-Liquid - 1 litre

Type	MHz	dB1	dB2	dB3
DVB-T2	470 - 690	44	52	59
LTE / 5G wide	700 - 750	44	52	59
GSM, LTE	920 - 960	44	52	60
GSM, LTE	1800 - 1880	44	53	60
DECT	1880 - 1900	44	53	62
LTE, 5G wide	2110 - 2170	44	54	63
W-LAN 2400	2400 - 2500	44	55	64
5G fast	3400 - 3600	44	58	66
W-LAN 5200	5150 - 5350	44	62	70

dB1-single layer - dB2-double layer - dB3-triple layer -- [4 sqm per litre]

Technical data

container size:	1 litre
color:	black
SD value: (DIN EN ISO 7783-2)	0.1 m
pH value:	8
adhesive pull strength:	7,5 N/mm ²
viscosity:	1400 mPas
density:	1.25 kg/litre
composition:	water, natural graphite, pure acrylic dispersion, carbon black, additives, preservative (BIT, INN, MIT),
binder:	VOC: 0.18 g/litre
preservative:	64 ppm BIT
GIS-Code:	34 ppm INN 3 ppm MIT
yield interior:	4 sqm/litre 8 sqm/litre
ground:	stable, non-greasy surfaces, MFT 5 °C
further processing: at temperature:	after about 24 hours > 5 °C
durability:	12 months (cool but frost-free (> 5 °C), avoid direct sunlight)
frost resistance	5 cycles
basis for inspection:	IEEE Standard 299™-2006
fire behaviour	DIN EN 13501-1
shield attenuation: 4 sqm per litre	max. ~ 52 dB (single layer) max. ~ 83 dB (double layer) max. ~ 85 dB (triple layer)
shield attenuation: 8 sqm per litre	max. ~ 39 dB (single layer) max. ~ 60 dB (double layer) max. ~ 74 dB (triple layer)

Scope of application

roof, ceiling and wall areas inside + outside



Art	MHz	Beschreibung
DVB-T2	470 - 690	digital video broadcasting - terrestrial, 2nd generation, TV via antenna
LTE / 5G wide	700 - 750	from 4G, now 5G NR without beamforming / MIMO
GSM, LTE	920 - 960	from 2G - D1, now 5G NR without beamforming / MIMO
GSM, LTE	1800 - 1880	from 2G - D2, E network, now 5G NR without beamforming / MIMO
DECT	1880 - 1900	wireless phone
LTE, 5G wide	2110 - 2170	from 3G, formerly UTMS, now 5G NR without beamforming / MIMO
W-LAN / WiFi 2400	2400 - 2500	wireless LAN
5G fast	3400 - 3700	5G NR - new frequency band with beamforming / MIMO
W-LAN / WiFi 5200	5150 - 5350	wireless LAN

Shielding values according to test report: EMF Test Lab Bavaria

Shielding effectiveness - HiFreq-Premium - 4 sqm per Litre - 470 MHz to 40.000 MHz (40 GHz)

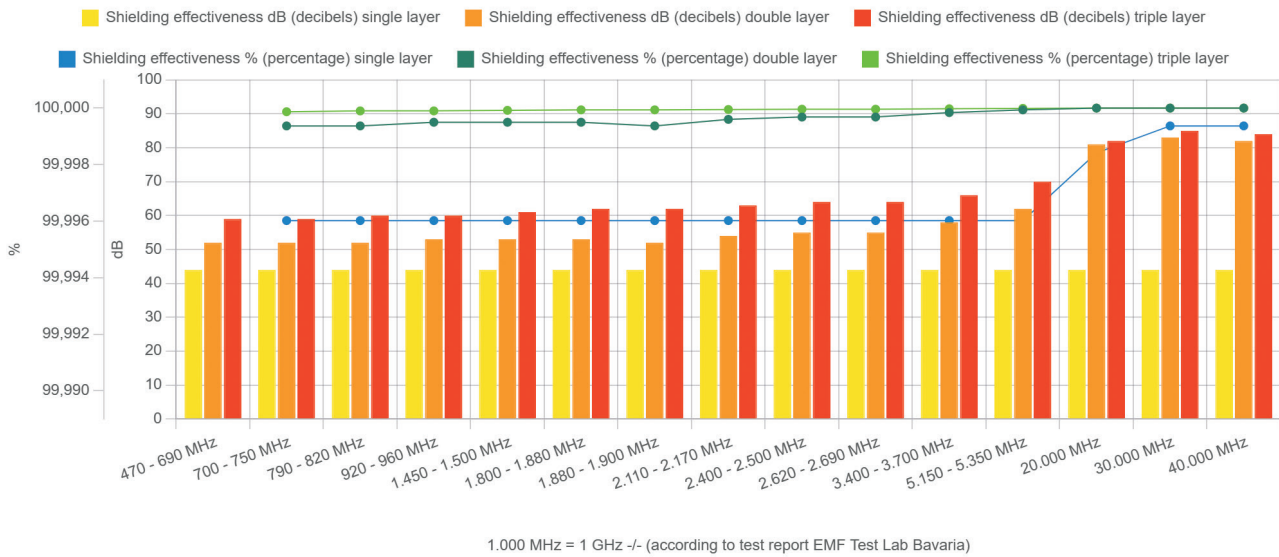

Shielding effectiveness - HiFreq-Premium - 8 sqm per Litre - 470 MHz to 40.000 MHz (40 GHz)

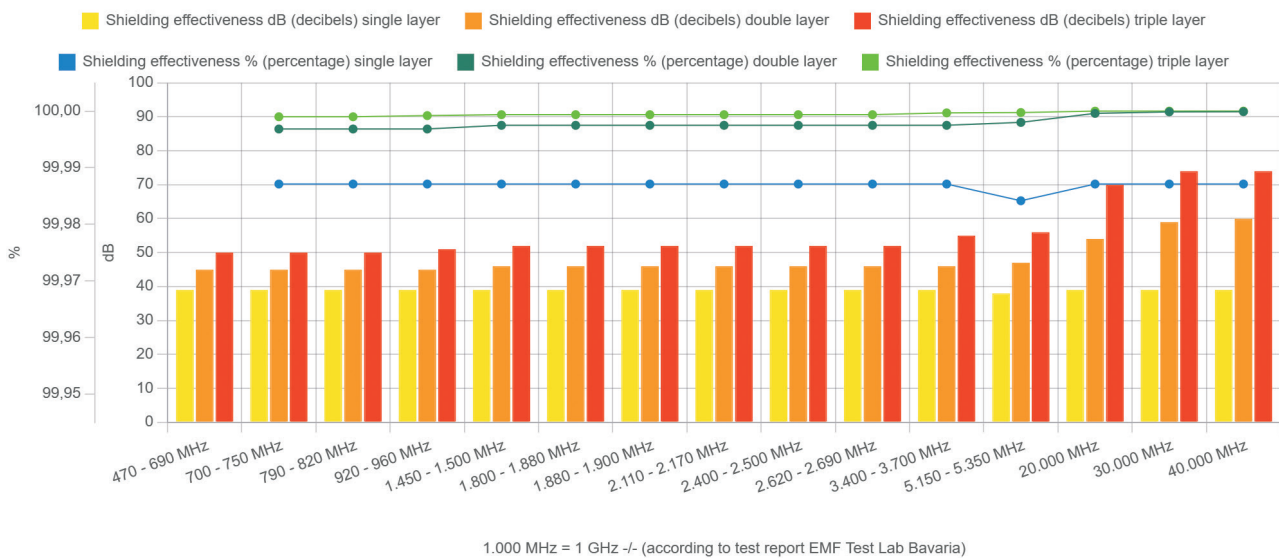



HF/NF wall coating (high frequency+low frequency)

Technical Data Sheet - Shielding Paint HiFreq Premium Liquid

Content - Possible processing

Grounding and safety regulations	1	Functional potential bonding - Prepare grounding	6
Safety equipotential bonding - Prepare grounding	2	Tips and frequently asked questions	7
Placing the grounding strap AEB 3.0	3		
Applying the shielding paint	4		
Applying the shielding paint to wood	5		

Grounding and safety regulations

The necessary installation must be carried out by a qualified electrician. A residual current circuit breaker (FI or RCD ≤ 30 mA) must be present in the circuit. Your electrician will install this standard device for you if it is not available. All electrical work (work on electrical devices and systems) must be carried out and checked by a qualified electrician or under their direction and supervision!

The grounding must be carried out in accordance with the applicable DIN/VDE regulations.

Safety equipotential bonding:

DIN 57100/VDE 0100 Teil 410 + Teil 540
DIN/VDE 0100 Teil 410 + Teil 540
DIN/VDE 0100 Teil 610 Abschnitt 4+5
VDE 0100

Functional potential bonding:

DIN VDE 0100-100
DIN VDE 0100-410
DIN VDE 0100-540
DIN VDE 0185-305-3
DIN EN 60445 (VDE 0197)

A: Safety Potential Equalisation (SPA)
Old stock and minor renovation

B: Functional potential bonding (FPA)
New construction and major renovation

This type of grounding, e.g. at a socket, is only recommended if the effort required to integrate the shielding surface into the functional potential bonding exceeds the benefit, e.g. if the shielding surfaces are located far away or if there is only one shielding surface (one room, one wall surface). The decision on where to ground is always made by your electrician, who knows the technology, your premises and the local regulations.

This type of grounding is to be used for larger renovations or new buildings. Here, the grounding is provided in the sub-distribution or main distribution board with a separately installed and marked FPA rail. All grounding and shielding wires of the shielded areas and cables are insulated or marked in pink. Each room is to be connected separately.

The earthing wire (yellow / green 2.5 mm²) is inserted into the existing socket and hard-wired. Your electrician will bring this wire with him.

Further information and an information flyer for your executing electrician can be found at www.funktionspotentialausgleich.de

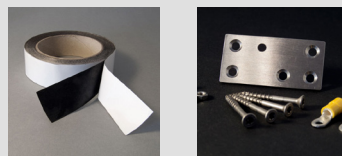
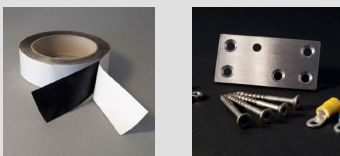

Important / Please note !!!

Have your electrical installation checked by a specialist / electrician. Grounding is only possible in a TN-S (3-wire) or a TT system. Grounding on an existing TN-C system is not possible or involves renewing some parts of the electrical installation (fig. TN-S). **The processing examples listed here refer exclusively to products offered by Biologa Danell. Due to various technical peculiarities of the materials, compatibility with screen products from other manufacturers is not given!**



HF/NF wall coating (high frequency+low frequency)

Safety equipotential bonding - Prepare grounding

Preparation for grounding / potential bonding

In order to avoid a coupling of low-frequency electric alternating fields or to dissipate them, the HiFreq Premium Liquid shielding colour must be integrated into the potential bonding.

If desired, the ground wire can be hidden in the wall.
Option 1: Fig. 1

A small slot is chiselled into the wall from the floor to the socket and the wire is inserted accordingly into the existing socket. The small slot can then be closed again (plaster) and the surface adjusted. Here, the Grounding plate EGP is mounted under the baseboard.

Option 2: Fig. 2
The Grounding plate EGP is placed next to the socket and the grounding wire is inserted into the existing socket from the back. The plate can be recessed into the wall and connected with the electrically conductive grounding strap (AEB 3.0). The grounding plate can remain visible or can be painted or wallpapered over.

Open laying Fig. 3

In cases where objects such as cabinets, shelves or similar are placed in front of the ground connection, the wire can also be run visibly to the box with nail clamps or a small channel. The grounding plate is mounted under the skirting board.

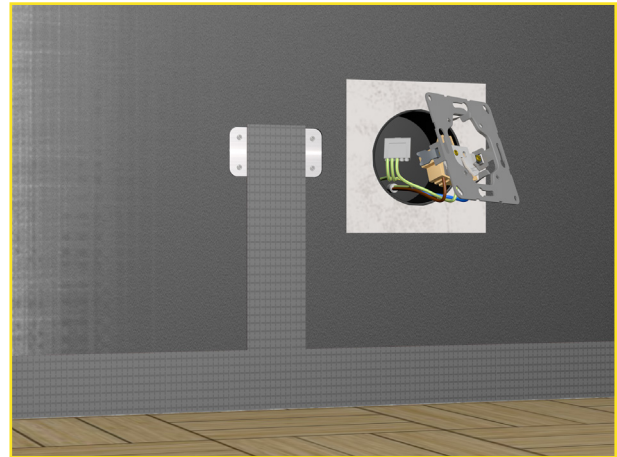

Fig. 2: Grounding plate next to socket / guiding the grounding strap / inserting the grounding wire into the wall socket.

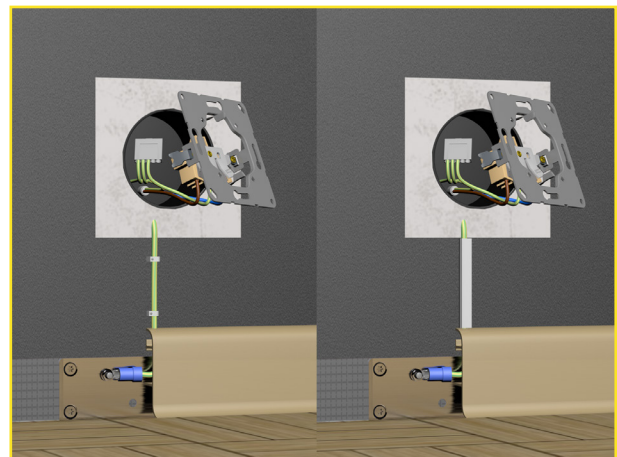

Fig. 3: Ground wire visible / earth wire laid in duct / inserting the earth wire into the wall box.

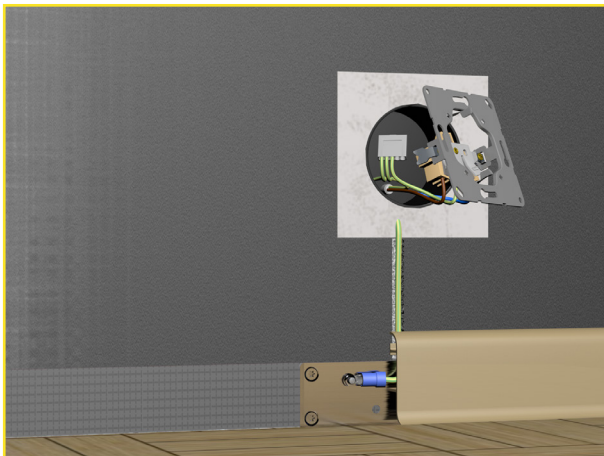
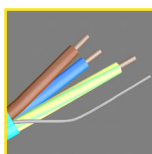

Fig. 1: Slot to socket / insertion of the grounding wire into the wall socket / grounding no longer visible at termination

Important / Please note !!!

Have your electrical installation checked by a specialist / electrician. Grounding is only possible in a TN-S (3-wire) or a TT system. Grounding on a TN-C system is not possible or involves renewing some parts of the electrical installation (fig. TN-S).

No grounding wire is included in the scope of delivery of the grounding plate to avoid improper connection of the components. Please inform your electrician about this; he will bring this in the appropriate length.



TN-S:
Usual number of cores in usual design in buildings. Three conductors phase L1 (brown or black), neutral conductor N (blue), protective conductor PE (yellow/green) - here additionally in shielded version with shielding wire. This is not available in a conventional electrical installation.



HF/NF wall coating (high frequency+low frequency)

Placing the grounding strap AEB 3.0

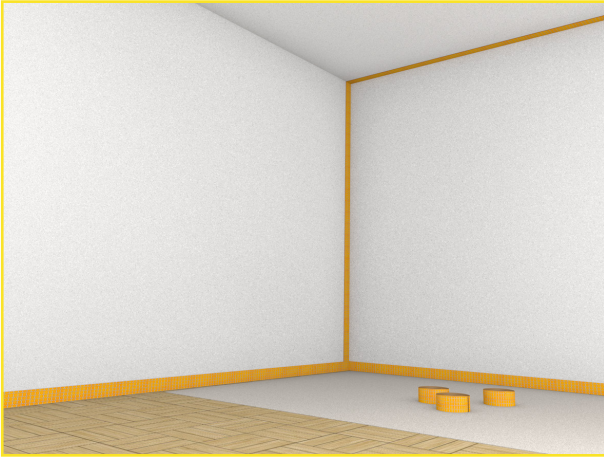

Fig. 4: Sticking on the electrically conductive grounding strap AEB in the base area. If the ceiling area is to be shielded, the grounding strap is led upwards and glued across the entire width of the ceiling.

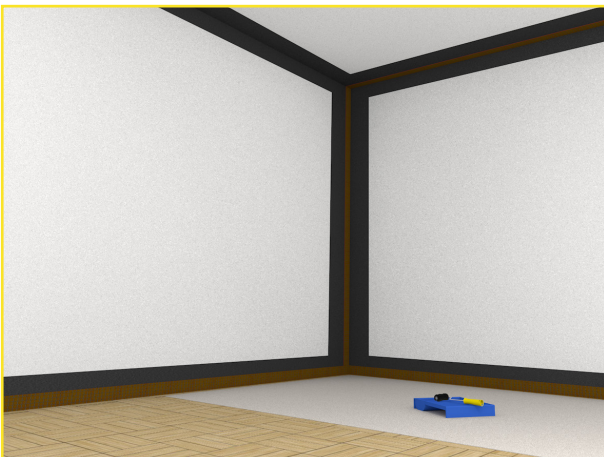

Fig. 5: First painting of the room corners, window reveals and the surfaces covered by the radiator.

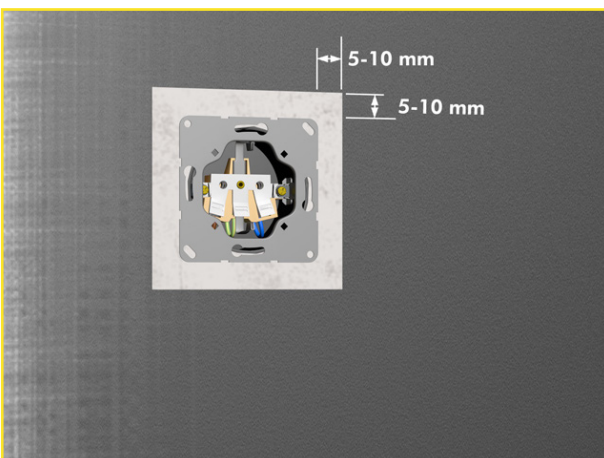

Fig. 6: Keep approx. 5 - 10 mm distance to socket and switch inserts.

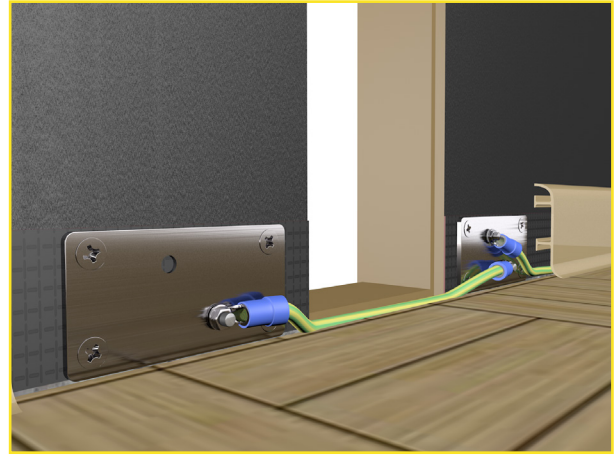

Fig. 7: Connecting room openings with floor bonding technique or by means of 2 grounding plates

Surface preparation

Sweep off, remove or repair loose parts, remove chalky, sanding substances by brushing. Remove sintered skin by sanding, release agents by washing off. Fill missing areas, holes, cracks, if necessary, with wall filler and sand off filler burrs. Tape open wallpaper seams, remove paste residues. Remove poorly adhering, non-adhesive, non-wetting or unsuitable old coatings completely. The HiFreq Premium Liquid shielding paint adheres to many surfaces, e.g. plasterboard, old paint coats, wallpaper, plaster, concrete, wood. Highly absorbent surfaces must be pre-treated with a primer.

Attaching the grounding strap AEB 3.0

Then apply the self-adhesive and electrically conductive grounding strap AEB in the skirting area and optionally up to the ceiling. (Fig. 4).

The AEB 3.0 grounding strap can be applied both on top of the shielding colour and underneath the shielding colour. For better durability and easier processing, we recommend sticking the tape under the shielding paint.

It is best to press the tape firmly onto the wall using a wallpaper push roller (small rubber roller).

In the area of doors and floor-to-ceiling windows (balcony), the strap can be continued along the floor under the door. It is also possible to connect two grounding plates using a grounding wire to the left and right of the door. The connecting cable can then be placed in the expansion joint of the floor. (Fig. 7) The grounding strap must not be laid in a closed circle. So save an opening in the room.

HF/NF wall coating (high frequency+low frequency)

Applying the shielding paint

Applying the HiFreq Premium Liquid shielding paint

Stir the paint for at least 2 - 3 minutes (preferably electrically) so that the incorporated carbon particles are evenly distributed. Processing can only take place at a room and substrate temperature of more than $> 5^{\circ}\text{C}$.

Add some paint from the container to the prepared paint tray and first paint the corners in the room and the small areas around windows, doors, switches and heating with a small roller, the flat brush and the radiator brush. (Fig. 5).

A distance of approx. 5 - 10 mm must be maintained around socket and switch inserts. According to VDE guidelines, the electrically conductive HiFreq Premium Liquid coating must not be conductively connected to the frames of the inserts. (Fig. 6)

Then paint the remaining larger areas - roller with pile 10 - 12 mm (Fig. 8).

IMPORTANT: Make sure that the paint is evenly (homogeneously) distributed over the surface. If sections of the surface are painted with different thicknesses, the screening attenuation changes depending on the thickness of the layer. Never thin the paint and never paint more than the specified size per litre. To avoid later waste, you should apply all the paint in the containers to the surfaces to be painted. This additionally increases the shielding effect. Dried-out paint can be disposed of in the normal residual waste. Please take the containers to the known collection points (yellow bag).

Further processing can be done after a drying time of 12 - 24 hours.

Tip: It is best to let the coating dry out well overnight in order to continue working the next day.

Attaching the Grounding plate EGP

If not already done, now drill the holes for the Grounding plate EGP. The holes are drilled through the shielding paint and through the grounding strap AEB 3.0. The holes can be vacuumed and painted over with shielding paint and a small brush.

Your electrician will now attach the grounding plate and connect the grounding wire to the grounding plate and the socket. The grounding accessories for connection are included with the Grounding plate EGP. (Fig. 9)

Further processing after wall coating and drying

After the shielding paint has dried, it can be reworked.



Abb. 8: Streichen der großen Fläche mit HiFreq Premium Liquid. Nach der Erdung der Schirmfläche an den vorgesehenen Erdungspunkten kann die Abschirmfarbe mit Deckfarbe überstrichen oder übertapiziert werden (Rolle mit Flor 10-12 mm).



Abb. 9: Befestigung der Erdungsplatte EGP und Anschluss des Erdungsdrahtes

Further processing after wall coating and drying

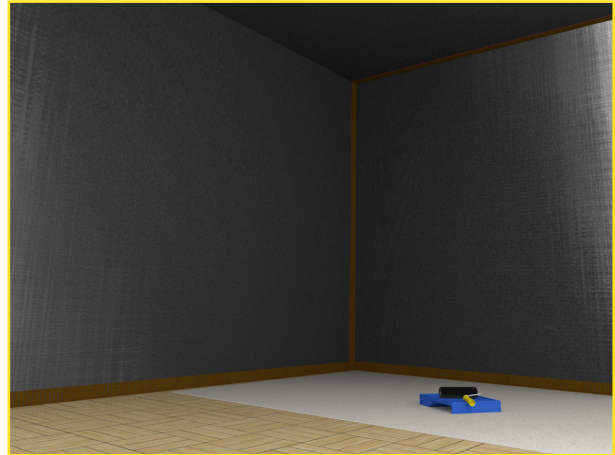
To achieve good coverage of the shielding paint, it is usually necessary to recoat it twice. The floating particles, which are not bound by the low binder content, mix with the first top coat and thus lead to darker results. The first coat can be applied at the maximum thinner level specified by the manufacturer. The second top coat should be applied undiluted if possible. After the first coat has dried and a second top coat has been applied, the surface will be pure white again. (Fig. 14 - Last page). Wallpapering over is also unproblematic. In this case, a deep, adhesive or alternating primer is painted on the shielding paint. The wallpaper can then be covered with wallpaper paste for heavy wallpapers.

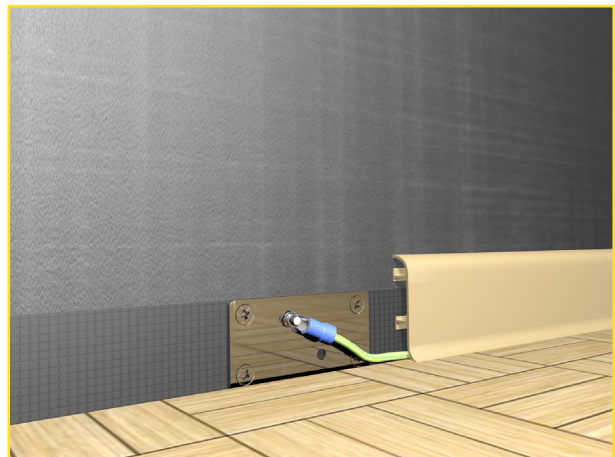

HF/NF wall coating (high frequency+low frequency)

Applying the shielding paint to wood

Surface preparation

Remove and repair loose parts. Remove impurities by sanding or washing off. If necessary, fill missing areas, holes, cracks and sand off burrs. Completely remove poorly adhering, non-wetting or unsuitable old coatings such as varnishes. The HiFreq Premium Liquid shielding paint adheres to many surfaces, e.g. plasterboard, old paint coats, wallpaper, plaster, concrete, wood. Highly absorbent surfaces must be pre-treated with a primer.

Applying the HiFreq Premium Liquid shielding paint

Stir the paint for at least 2 - 3 minutes (preferably electrically) so that the incorporated carbon particles are evenly distributed. Processing can only take place at a room and substrate temperature of more than $> 5^{\circ}\text{C}$.

Add some paint from the container to the prepared paint tray and paint the e.g. door frame or door leaf with a small roller.

IMPORTANT: Make sure that the paint is evenly (homogeneously) distributed over the surface. If sections of the surface are painted with different thicknesses, the screening attenuation changes depending on the thickness of the layer. Never thin the paint and never paint more than the specified size of 5 - 6 m² per litre. To avoid later waste, you should apply all the paint in the containers to the surfaces to be painted. This additionally increases the shielding effect. Dried-out paint can be disposed of in the normal residual waste. Please take the containers to the known collection points (yellow bag).

Further processing can be done after a drying time of 12 - 24 hours.

Tip: It is best to let the coating dry out well overnight in order to continue working the next day.

Further processing after wood coating and drying

After the shielding paint has dried, it can be recoated. To achieve good coverage of the shielding paint, it is usually necessary to recoat it twice. The floating particles, which are not bound by the low binder content, mix with the first top coat and thus lead to darker results. Both top coats should be applied undiluted if possible. After drying of the first coat and reworking with a second top coat, the surface becomes pure white.

Grounding

Grounding is not absolutely necessary for door leaves if the surrounding surfaces are also shielded and grounded. If only the door frame and the door leaf are shielded, a Grounding plate EGP can be fitted in the lower door leaf area if required.



HF/NF wall coating (high frequency+low frequency)

Functional potential bonding - Prepare grounding

Processing of the HiFreq Premium Liquid

Follow steps 4 - 8 as described above.

Preparation for grounding / potential bonding (FPA)

In order to avoid coupling of low-frequency electric alternating fields or to dissipate them, the HiFreq Premium Liquid shielding paint is integrated into the functional potential bonding for larger renovations or new buildings.

In this case too, the Grounding plate EGP is fitted under the skirting board.

The grounding cable is placed from the grounding plate to a sub-distribution board or main distribution board (fuse box) (Fig. 12).

A separate functional potential equalisation rail (yellow/green) is mounted and marked in the fuse box. This FPA rail is connected to the existing PE rail. (Fig. 13)

Further processing after wall coating and drying

After the shielding paint has dried, it can be reworked.

To achieve good coverage of the shielding paint, it is usually necessary to recoat it twice. The floating particles, which are not bound by the low binder content, mix with the first top coat and thus lead to darker results (in the case of white top coat, the first coat becomes grey). The first coat can be applied at the maximum thinner level specified by the manufacturer. The second top coat should be applied undiluted if possible. After the first coat has dried and a second top coat has been applied, the surface becomes pure white again. (Fig. 14). Wallpapering over is also unproblematic. In this case, a deep, adhesive or alternating primer is applied to the shielding paint. The wallpaper can then be covered with wallpaper paste for heavy wallpapers.

Quality labelling

A QS labelling in the distribution door signals the connection of the shielding surface to the FPA rail, warns of removal and notes the addresses of the expert involved as well as those of the responsible electrician. QS labelling - enclosed with boxes and installation cables in the form of the FPA flyer. On request individually.

Further information on functional potential bonding, under: www.funktionspotentialausgleich.de

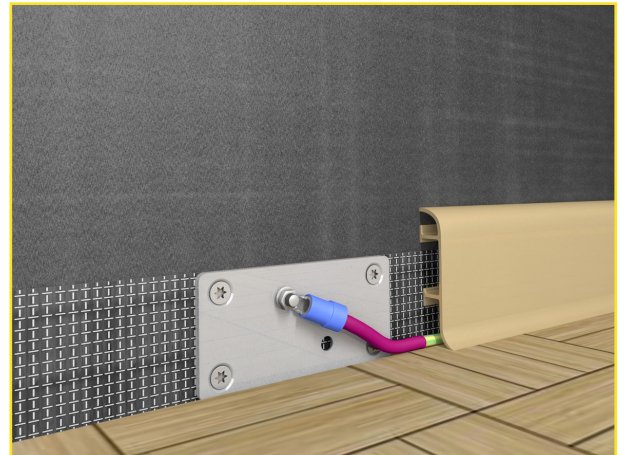

Fig. 12: Grounding plate under skirting board / guiding the grounding strap to the sub-distribution board

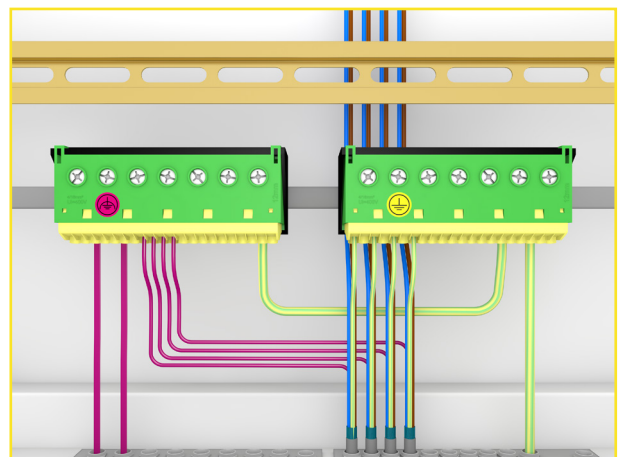

Fig. 13: Connection on the left of the functional equipotential bonding conductor in the power supply sub-distributor with the separately marked functional equipotential bonding bar.

In diesem Schaltschrank sind **geschirmte Leitungen** und/oder **elektrisch leitfähige Wandflächen** angeschlossen.

Ihr ausführender Elektriker:

Die Schirm-Beidrähte der Leitungen sowie der Anschluss der Wandflächen sind mit der Schutzleiter-Schiene verbunden. Bei Lösen dieser Verbindung wird die Funktion der Schirmung aufgehoben.

Ihr beratender Sachverständiger / Messtechniker:

Zur Erhöhung des Personen- und Sachschutzes sind alle geschirmten Leitungen und Wandflächen über einen Fehlerstromschutzschalter mit einem Bemessungsdifferenzstrom ≤ 30 mA geführt.



Zutreffende Normen:
DIN VDE 0100-100
DIN VDE 0100-410
DIN VDE 0100-540
DIN VDE 0185-305-3
DIN EN 60445 (VDE 0197)

www.funktionspotentialausgleich.de

QS labelling available from Biologa Danell



HF/NF wall coating (high frequency+low frequency)

Tips and frequently asked questions

IMPORTANT / Tips

Make sure that the paint is evenly (homogeneously) distributed over the surface. If sections of the surface are painted with different thicknesses, the screening attenuation changes depending on the thickness of the layer. Do not dilute the paint and never paint more than the specified area. To avoid later waste, you should apply all the paint in the containers to the areas to be painted. This additionally increases the shielding effect. Dried-out paint can be disposed of in the normal residual waste. Please take the containers to the known collection points (yellow bag).

The holes to be drilled can be made in advance at the fixing point of the grounding plate or after painting and after the shielding surface has dried. Some shielding paint should be left over to paint the holes after drilling. The shielding paint can also be reapplied under the grounding plate to improve the contact between the plate and the grounding strap.

The grounding plate is not supplied with a grounding wire to prevent improper connection of the components. Please inform your electrician about this and he will bring along the appropriate length.

Frequently asked questions	Answers
General test of the absorbency of a surface	The absorbency can be tested by wetting with water. If the water beads off, the surface is not or only slightly absorbent. If water is absorbed quickly and the colour is clearly dark, this is a note for highly absorbent surfaces.
Can the shielding paint HiFreq Premium Liquid also be used on wallpaper?	Yes, in principle you can also apply the HiFreq Premium Liquid shielding paint directly to wallpaper. However, this should not be water-repellent and should not have been stitched over dozens of times. We recommend always applying the paint underneath wallpaper or a coat of paint. However, it certainly makes sense to apply the shielding paint directly to wallpaper if the shielding measure is to be removed again after moving out or moving in, for example, in a rented flat. Talk to your landlord in advance of a shielding measure.
Can pictures or other objects be attached to the wall or ceiling after completion of the shielding project?	Fixing pictures or other objects is no problem and can also be done on a shielding surface. Small nails or screws may be used. Please note the cable routing of your electrical installation in advance! in order not to damage existing cables in the wall. You can find appropriate cable finders in DIY stores or at specialist dealers.
Can the grounding according to version A also be carried out at other wall or ceiling outlets?	When coating only one ceiling, for example, the grounding can also be done via a light outlet. In this case, the grounding strap AEB 3.0 is routed close to the outlet. The EGP is then mounted next to the light outlet.
How can the shielding paint be removed again?	If wallpaper is used, the shielding surface can be easily removed by removing the wallpaper. Have your electrician remove the ground connection beforehand. When installing under wallpaper, directly on the wall surface, the wall surface must be sanded or milled down (approx. 1 - 2 mm).